

An advertisement for the Hobie Kayaking & Fishing Collection. The background is a scenic view of two women kayaking on a body of water. The kayaker in the foreground is on a white Hobie kayak, wearing a yellow and black life vest. The kayaker in the background is on an orange and white Hobie kayak, wearing a blue life vest. The water is a deep blue-green color. In the background, there are yellowish-brown rock cliffs with a cave-like opening. The sky is blue with some clouds. The Hobie logo is in the top left corner, and the text 'HOBIE KAYAKING & FISHING COLLECTION' is on the left side. At the bottom, the text 'GET OUT ON THE WATER' is written in large white letters.

Hobie®

HOBIE KAYAKING & FISHING COLLECTION

GET OUT ON THE WATER



DESIGN AND INNOVATION. QUALITY AND CRAFTSMANSHIP.

IN 1950, HOBIE ALTER SHAPED HIS FIRST SURFBOARD IN HIS PARENTS' GARAGE IN LAGUNA BEACH, CALIFORNIA. HIS VISIONARY DESIGNS CHALLENGED THE LIMITS OF WATERSPORTS AND INSPIRED A CULTURE OF INGENUITY AND CRAFTSMANSHIP THAT LIVES ON TODAY. STARTING WITH SURFBOARDS AND WORLD-CLASS CATAMARANS, TO REVOLUTIONARY PEDAL KAYAKS AND STANDUP PEDALBOARDS, HOBIE IS DRIVEN BY A PASSION FOR DELIVERING THE MOST ADVANCED, ENJOYABLE AND ACCESSIBLE WATERSPORT PRODUCTS AVAILABLE. THE HOBIE BRAND CONTINUES TO BE SYNONYMOUS WITH LEADING-EDGE ADVENTURE ON THE WATER.

TODAY, HOBIE'S PASSION FOR THE WATER IS BUILT INTO EVERY KAYAK WE MAKE. BASED IN OCEANSIDE, CALIFORNIA, HOBIE IS STEADFAST IN ITS UNWAVERING COMMITMENT TO UNSURPASSED QUALITY, EXPERT CRAFTSMANSHIP AND SUPERIOR PERFORMANCE.

MIRAGEDRIVE GUIDE Patented Pedal Propulsion Systems

POWERED BY
MD GT

MirageDrive with Glide Technology and Kick-Up Fins for an ultra-smooth ride.

MIRAGE ITREK SERIES
MIRAGE PASSPORT 10.5
MIRAGE PASSPORT 12
MIRAGE COMPASS DUO (1 of 2 Drives)



POWERED BY
MD 180

Hands-free propulsion in both forward and reverse with Kick-Up Fin Technology.

MIRAGE LYNX
MIRAGE COMPASS
MIRAGE COMPASS DUO (1 of 2 Drives)
MIRAGE REVOLUTION SERIES
MIRAGE OASIS
MIRAGE OUTBACK
MIRAGE PRO ANGLER 12
MIRAGE PRO ANGLER 14
MIRAGE TANDEM ISLAND



POWERED BY
MD 360

Revolutionary movement in full-circle, 360 degrees with Kick-Up Fin technology.

MIRAGE PRO ANGLER 12 & 14
with 360 TECH



1950 FIRST SURFBOARD

Hobie Alter shapes his first surfboard in his parents' Laguna Beach garage

1968 HOBIE 14

A lightweight, beachable catamaran sails into the spotlight

1970 HOBIE 16

Classic. The two-person, double trapeze catamaran

1982 HOBIE 33

The fastest, sleekest monohull in its class

1994 HOBIE WAVE

A user-friendly and minimalistic, rotomolded catamaran

1997 INTRODUCTION OF THE GROUNDBREAKING MIRAGEDRIVE®
Revolutionizing kayaking forever

2009 MIRAGE PRO ANGLER 14

Hobie lands a massive strike with a feature-laden fishing boat

2016 MIRAGEDRIVE 180

Reverse is added to the legendary MirageDrive

2019 LAUNCH OF MIRAGEDRIVE 360

Only Hobie delivers power in every direction

2020 MIRAGE ITREK SERIES LAUNCH

Hobie introduces new inflatable kayak line

1950

1954 HOBIE SURF SHOP OPENS
The doors to the first Hobie Surf Shop open in Dana Point, CA

1960

1958 NEW GENERATION OF SURFING
Invents Fiberglass/foam-core boards with Grubby Clark

1970

1980

1982 HOBIE POLARIZED
Visibility for the best experiences on the water

1990

1995 HOBIE TRIFOILER
Drops jaws with its staggering speed

2000

2001 MIRAGE® OUTBACK
The Mirage Outback introduced kayak fishing in an SUV package

2006 MIRAGE ADVENTURE ISLAND

The do all trimaran: sail, pedal and paddle

2010

2016 MIRAGE ECLIPSE
Hobie makes a splash with the world's first standup pedalboard

2018 REDESIGNED MIRAGE OUTBACK

Introducing the newly redesigned, improved Mirage Outback

2020

2020 KICK-UP FINS
Kick-Up Fin technology added to selected MirageDrives

2021 MIRAGE LYNX

Swift & agile with advanced tech

a TRADITION OF INNOVATION—

BY DESIGN.



1. INVENTING
BREAKTHROUGH CONCEPTS



2. RIGOROUS STRESS TESTING

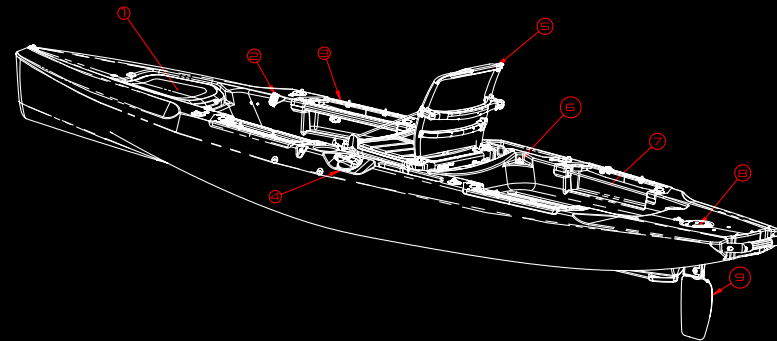

3. REFINEMENT AND
MANUFACTURING



4. PATENTED INNOVATION



5. CONTINUOUS
PRODUCT EVOLUTION





MIRAGE ITREK SERIES LIGHTWEIGHT & LIGHTNING FAST

The iTrek inflatable kayak series strikes the perfect balance between superior performance and portability with the MirageDrive with Glide Technology and Kick-Up Fins.

The Mirage iTrek 9 Ultralight and iTrek 11 are our lightest and most maneuverable pedal kayaks - the perfect solution for kayakers who appreciate the perks of an inflatable, yet still want all the capabilities of a high-performance platform.

The iTrek 9 Ultralight's high-tech drop stitch construction inflates to 10 PSI, delivering rugged rigidity and nimble performance in an unbelievably lightweight package. The hull construction combined with EVA standing pads allows it to be used as a seated kayak or standup paddleboard. Easy to stow and even easier to transport, just toss it into the back of your car, load it in the RV or check it as luggage for your next flight.

Built for everything from day trips to overnight escapes, the Mirage iTrek 11 inflatable kayak delivers the speed, stability, and tracking of a rigid kayak but without all the extra weight. The high-performance, lightweight construction features a rugged inflatable drop-stitch hull with triple-chamber construction. Each iTrek Series kayak features state-of-the-art seating built with breathable monomesh and ripstop nylon. Also included are a rolling travel bag with portable hand pump and high-volume electric pump.

Available Colors:



iTREK 9

iTREK 11



MIRAGE iTREK 14 DUO MIRAGE iTREK FIESTA

PARTY ON THE WATER

If you're looking to have some serious fun on your next family outing, look no further than the inflatable Mirage iTrek 14 Duo and Fiesta.

Built for two, the iTrek 14 Duo strikes the perfect balance of stability and speed. Two MirageDrives with Glide Technology and patented Kick-Up Fin Technology optimizes locomotion.

Get ready for a party on the water. The Fiesta is fast and versatile. With room for the whole family, we've integrated social seating, making it the perfect watercraft for spending time on the water playing games or putting your feet up and hanging out. With four seats, two MirageDrive GTs with Kick-Up Fins, and its high-tech drop stitch triple-chamber construction, you'll have the space and the power to bring the whole family along for the party of a lifetime.

Mirage Fiesta is shown at left upgraded with 4 MirageDrives. Comes standard with 2 MirageDrives.

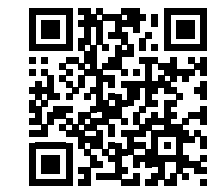

Scan code with smartphone camera for video link

Available Colors:  POWERED BY MD GT



iTREK 14 DUO

iTREK FIESTA

MIRAGE ITREK SERIES

CONVENIENCE, PORTABILITY & A GREAT RIDE

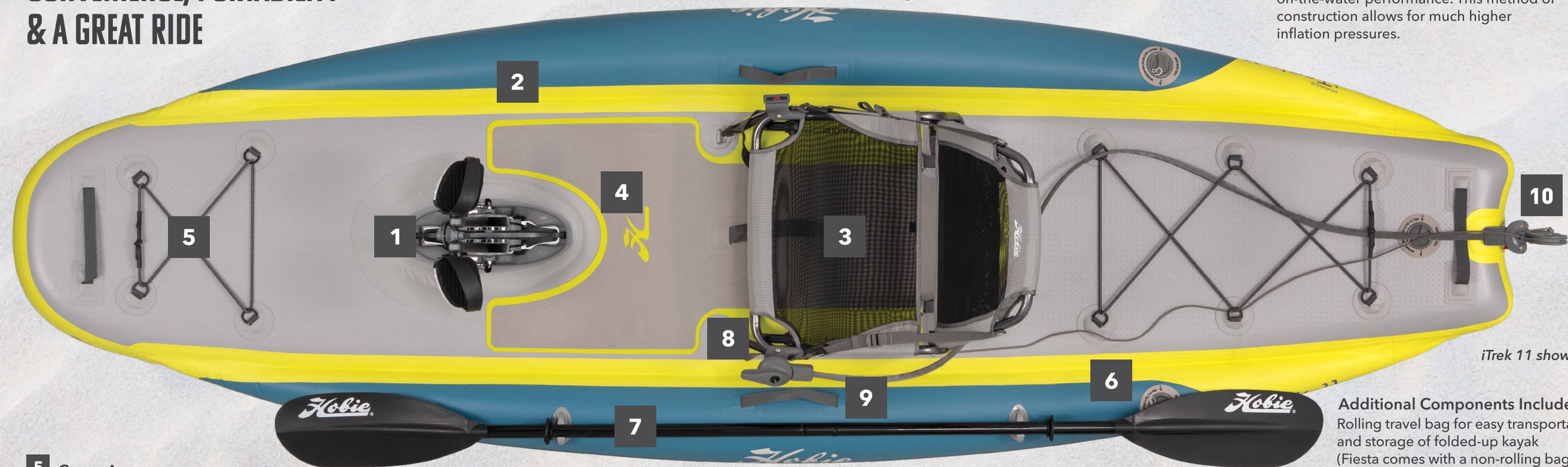

iTrek 11 shown

1 MirageDrive with Glide Technology
Intuitive and efficient, Hobie's MirageDrive GT with Kick-Up Fin Technology offers smooth and powerful pedaling.

2 550 Denier PVC Hull
Built tough for years of fun.

3 iTrek Elevated Seating
Aluminum frame seating with breathable monomesh and ripstop nylon provides lightweight, quick drying, cool and comfortable seating. It can also be used as a beach chair.

4 Diagonal Drop Stitch Floor and EVA Pad
Thousands of tiny threads connect the top and bottom layers of the floor, providing remarkable structural rigidity for optimal on-the-water performance. This method of construction allows for much higher inflation pressures.

5 Cargo Areas
The front and rear Cargo Areas with Bungee® tie-downs ensure gear is still there when you get to camp.

6 Locking Valves
Valves lock into the pump for easier inflation and lock into open position for quick deflation.

7 Four Piece Aluminum Paddle*
8 Rudder Control
Steer with your fingertips. The detachable steering handle provides smooth, low friction operation that can be attached to either side of the seat.

*Mirage iTrek 9 and Fiesta come standard with a Three-Piece Fiberglass standup paddleboard paddle

9 Carry Handles
Portage made easy with handles forward, aft and amidship.

10 Removable Rudder
The entire rudder and steering system quickly attaches/detaches from the hull for easy storage when packing up at the end of the day. When attached to the hull, single line rudder blade retraction/deployment provides incredible handling and maneuverability.

Additional Components Included:
Rolling travel bag for easy transportation and storage of folded-up kayak (Fiesta comes with a non-rolling bag equipped with multiple carrying handles), Cup Holder, Electric Pump, Dual Action Hand Pump for inflation and deflation.

Optional Accessories:
Plug-in Cart for transportation, adhesive iAccessory Mounts, Rod Holder, and other fittings. See our Parts and Accessories Catalog for more.

MIRAGEDRIVE GT

WITH KICK-UP FINNS

The patented, time-tested Hobie MirageDrive pedal system with Glide Technology and Kick-Up Fins allows you to charge through the water. Power forward virtually hands-free. With roller bearings at key friction points, there is less resistance and enhanced performance. Our Kick-Up Fin Technology takes the worry out of kayaking in shallow, structure-filled waters by automatically "kicking up" on impact. Logs, kelp, rocks? No problem. The MirageDrive GT comes standard on all 2022 Mirage iTrek Series and Mirage Passport kayaks.

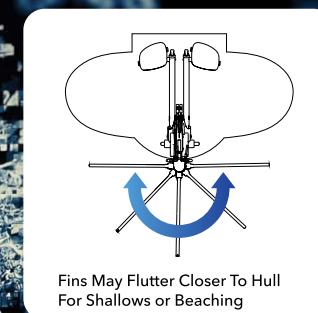
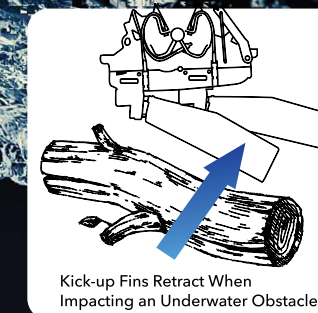



MIRAGE PASSPORT 10.5

YOUR ONE WAY TICKET TO ANYWHERE

Powered by the MirageDrive with Glide Technology and Kick-Up Fins, the Mirage Passport 10.5 makes it possible to reach isolated beaches and remote waters, bringing you closer to nature and further from the hustle and bustle. The Glide Technology ensures a smooth ride by way of added roller bearings at key friction points.

Every feature is designed with your comfort in mind, starting with an ergonomically designed mesh aluminum frame seat. Sail open water or fish the flats, thanks to the sail-ready vertical accessory mount and molded-in rod holders. Dual mounting tracks keep your accessories within reach while the 8" Twist and Seal Hatch provides extra storage. The easy-to-use steering system and simplified version of our Twist and Stow Rudder puts navigation at your fingertips and a smile on your face.



Available Colors:

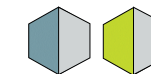

MIRAGE PASSPORT 12

STEALTH ON THE WATER

The Mirage Passport 12 takes you where you want to go with ease and world-class authority. This 12-foot kayak is powered by the MirageDrive with Glide Technology and Kick-Up Fins. When you're not relaxing in the Passport's breathable mesh seat, a wide cockpit area with EVA floor padding provides a stable platform for standing and stretching your legs or casting a line. There's plenty of real estate to stash equipment on the bow or stern cargo areas and more below deck access through the center 8" Twist and Seal Hatch.

Anglers will be happy that the Passport 12 has a transducer cavity and scupper for quick install of your preferred fishfinder and a Power-Pole® Micro bracket indent to easily mount your favorite shallow water anchor. Additional features include steering system with stowable rudder, two fishing rod holders, accessory tracks, and under seat and gunnel tackle storage.



Available Colors:



POWERED BY
MD GT



MIRAGE PASSPORT

1 MirageDrive GT
Featuring our legendary MirageDrive with Glide Technology and Kick-Up Fins that automatically retract on impact.

2 8" Twist and Seal Hatch
Corkscrew closures and hinged lids for in-hull storage.
Upgrade to the Rectangular Hatch for more space.

3 Suspended Mesh Aluminum Frame Seat
Lightweight and comfortable, breathable mesh seat.

4 Rudder Control
Intuitive and effortless fingertip steering.

5 Aluminum Two-Piece Paddle
For added safety and because sometimes it's just too shallow to pedal.

6 Stowable Rudder
Deploy when on the water and then stow for easy transport.



7 Bow Storage with Bungee®
Large bow cavity for extra storage space. Add optional 8" Twist and Seal hatch for below deck storage.*

8 Forward Accessory Mount
Stands ready for the Hobie Mirage Sail Kit or Bimini Sunshade.

9 EVA Padded Standing Platform
Confidently stand and cast on the redesigned cockpit, complete with EVA pads and extra width for stability.*

10 Accessory H-Track Mounts
Two H-Tracks provide infinite mounting options for your Go-Pro and any items you need close.

11 Accessible Tackle Storage
Two recesses with Bungee closures keep tackle boxes close.*

12 H-Bar Ready
Forward recesses provide precise placement for simple H-Bar setup.*



Fishfinder Ready
Includes a transducer cavity and mounting plate for you to install a fishfinder.*

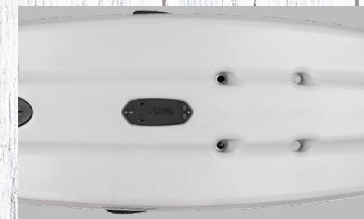

13 Power-Pole® Micro Mounting Pad
Molded in mounting surface to quickly install your Power-Pole Anchor System.* Requires upgraded hatch.

14 Carrying Handles
Provided at the bow and stern and two along the sides for easy handling and quick transport.

15 Rod Caddies
Keep rods within arm's reach and ready for your next cast.



Mirage Passport 12 shown

*Available on Mirage Passport 12 only.



MIRAGEDRIVE 180 a FORCE OF NATURE

EXPERIENCE 20 YEARS OF INNOVATION... PERFECTED.
IN 1997, HOBIE PERMANENTLY REVOLUTIONIZED KAYAKING
WITH GROUNDBREAKING FIN TECHNOLOGY.

The most significant technological innovation in modern kayak history, the MirageDrive, immediately revolutionized the sport of kayaking upon its introduction in 1997. As the unquestioned leader in pedal propulsion for over 20 years, Hobie has been innovating ever since. With the patented MirageDrive 180 with Kick-Up Fins that automatically "kick-up" when an obstacle is hit and redeploy when clear, Hobie has set a new standard for pedal drives. This award-winning fin technology delivers seamless adjustability, dependability, and full power in both forward and reverse. Best of all, it's completely beachable with the push of the pedal. The MirageDrive 180 is featured on the Mirage Lynx, Mirage Compass and Compass Duo, Mirage Outback, Mirage Revolution® Series, Mirage Oasis®, Mirage Pro Angler Series and Mirage Tandem Island.

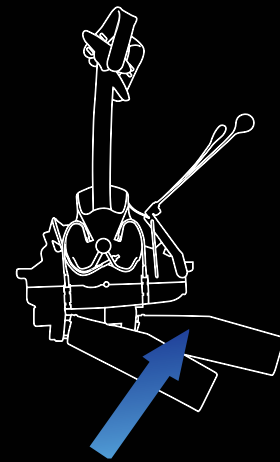

Kick-up Fins Retract When Impacting an Underwater Obstacle

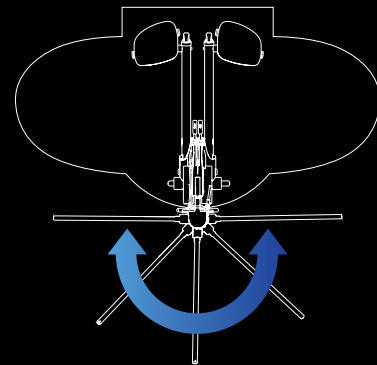

Fins May Flutter Closer To Hull For Shallows or Beaching

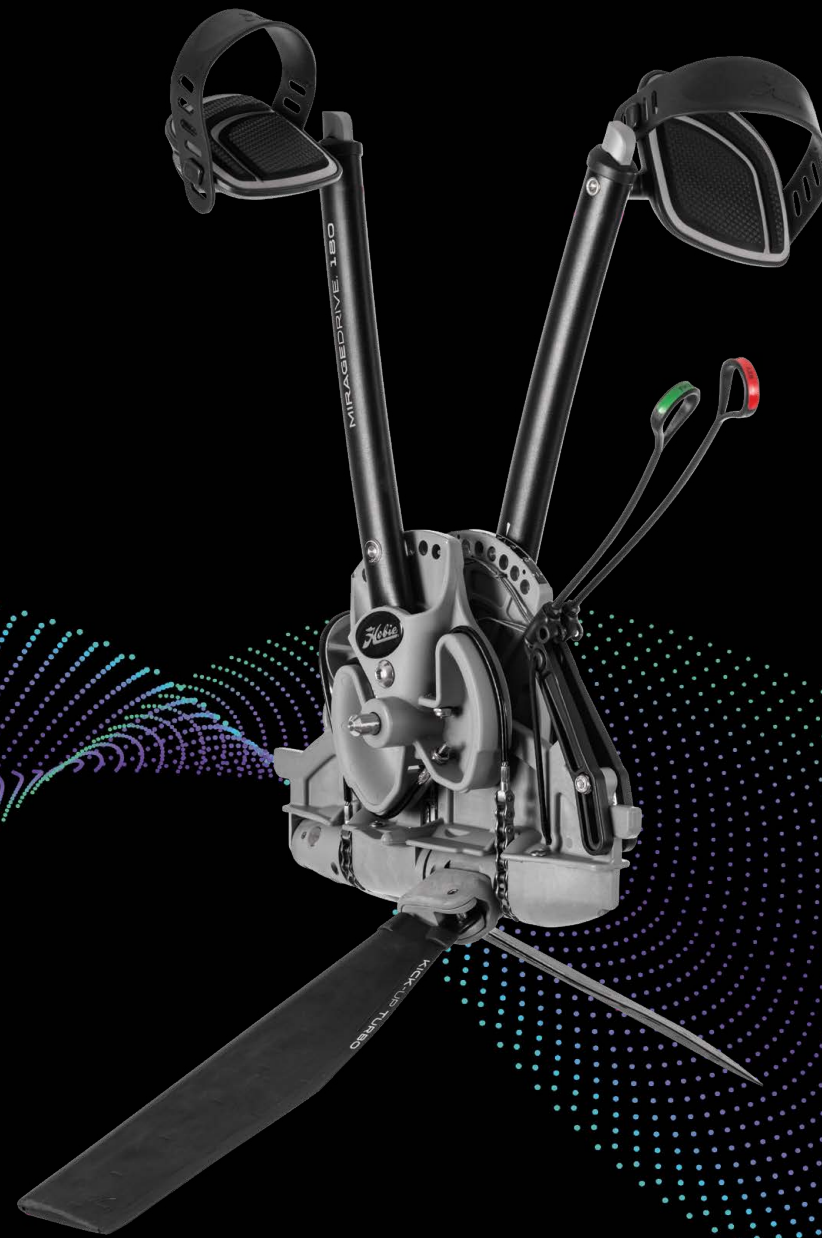

THE DESIGN ADVANTAGE

Revolutionary 180 Shifters

Instantly spin the fins from forward to reverse with a quick pull of the cable.

Kick-Up Fins

Kick-Up Technology provides the power to charge through the water as never before. Logs, kelp, shallows, rocks? No problem!

Hands-Free Propulsion

Keep your fishing rod, camera, or cold drink where they belong - in your hands.

Navigate Shallow Water

Fluttering the fins by using partial pedal strokes allows propulsion in very shallow water. Unlike propeller based pedal systems, the fins fold up flush with the hull for easy beaching.

On-Water Debris

The natural back and forth motion of the fins sheds debris and vegetation and won't twist up and get stuck like many propeller drives.

Strength and Durability

Built from the toughest components and designed to hold up to the harsh environments, extreme temperatures and underwater impacts, you won't find a tougher, better built drive.

Glide Technology

Advanced roller bearings at key friction points reduce resistance for an ultra-smooth ride.

The Click and Go System

Allows for quick and easy MirageDrive installation and removal.

Easy Maintenance

A quick rinse with fresh water is all you need once you're done for the day.

Height Adjustable

With the simple push of a button, the cranks adjust effortlessly to fit kayakers of different sizes, short to tall.

MIRAGE LYNX

ADVANCED TECHNOLOGY FOR SWIFT & AGILE ACTION ON THE WATER

Simple by design and versatile by nature, the Mirage Lynx is everything a kayaker wants and more. Race across the surface in its low-profile, flat-bottom design and experience the full speed of the Mirage Lynx with the forward and reversing MirageDrive 180 with Kick-Up Fins. Lightweight materials meet optimal performance with ACE-TEC Technology that is perfect for a weekend of exploring. Designed for maximum comfort on the water with an EVA standing pad, elevated, breathable monomesh seating that stays dry, even in rough conditions, and a wide V-hull bow to provide a smoother ride. Equipped with a removable rudder system, the Mirage Lynx tracks straight over long distances and maneuvers sharply around docks. With multiple molded-in cargo areas with Bungee® tie-downs and a convenient pouch on the seat back, there's plenty of space to stash all your gear. To top it off, the Lynx is fish-friendly for both freshwater and saltwater anglers. From molded-in inserts for our stand up H-Bar, a track system to attach your fishing accessories, to Power-Pole® ready scupper, and inserts along the back for H-Rail upgrades. It even includes a transducer cavity for installing a fish finder.



Scan code with smartphone camera for video link

Available Colors:

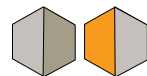

MIRAGE LYNX

1 MirageDrive 180 with Kick-Up Fins
Intuitive and efficient, Hobie's MirageDrive 180 with Kick-Up Fin Technology offers smooth and powerful pedaling.

2 Mid-Ship Carry Handle
Mid-Ship handles for side carrying and overhead loading.

3 Elevated Seating with Breathable Monomesh Fabric
Aluminum frame seating with breathable mesh provides lightweight, quick drying, cool and comfortable seating. It can even be used as a beach chair.

ACE-TEC Construction
Lightweight construction with an EPS foam core, fiberglass wrap and ASA thermoformed plastic skin.

4 Two-Piece Kayak Paddle
Negotiate surf-strewn beaches and rocky inlets with additional confidence, or go old school and paddle for an upper body workout.

7 Forward Accessory Mount
Upgrade your yak with a bimini sunshade or sail kit.

8 Carry Handle
T-handle for firm grip and comfort transporting your Lynx.

Stern Loaders
Loading feet at the stern make for easy car top loading.

5 Power-Pole Ready
Inshore anglers can easily install Power-Pole Shallow Water Anchor.

6 Removable Rudder
Quickly attaches and detaches from the hull for storage when packing up at the end of the day.

Cart Scuppers
Fast draining cart scuppers to make transport a breeze.

9 Bow Storage
Easily access your gear and store with ease with Bungee® tie downs.

10 H-Bar Standing Support Ready
H-Bar ready for stand up ease and support.

FishFinder Ready Transducer Cavity
Quickly and easily install your favorite fishfinder.

11 Rudder Control Steering Handle (L or R)
Soft handle makes fingertip steering easy.

12 Integrated Accessory Mounting Tracks
Truly make the Lynx yours by adding upgraded accessories.

13 EVA Standing Pad
Delivers supreme comfort, traction and sound dampening qualities when standing.

H-Rail Accessory Ready
Customize the Lynx with your favorite H-Rail accessories.

14 Cargo Storage with Bungee Tie Downs
Plenty of storage to pack for your adventure.

Detail of Advanced Monomesh Material

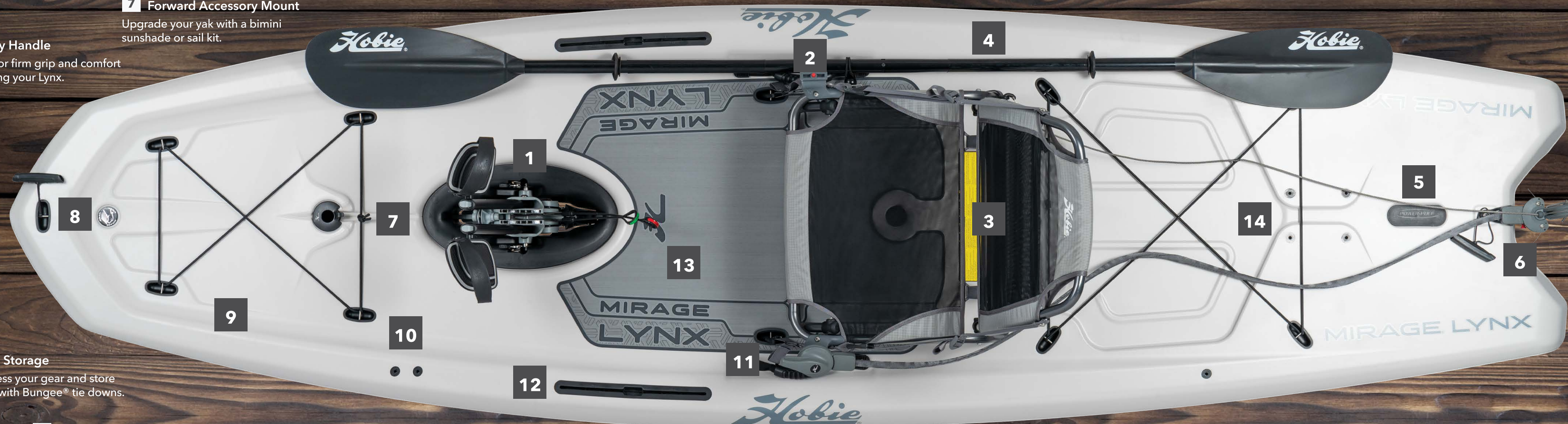

MIRAGE COMPASS

HIGH PERFORMANCE MEETS SIMPLICITY

Enjoy the comfort of a brilliantly simple, high-performance and fully customizable platform all while experiencing world class kayaking. The new Compass seat offers incredible comfort, durability and breathability with monomesh and ripstop nylon construction and an anodized aluminum alloy frame.

The Compass' extra-wide, rock-steady 34" hull and standing deck provide unwavering stability for confidence and control. Ample cargo space and two molded-in rod holders offer quick and easy access to all your gear. Relish the power of pedal propulsion, in both forward and reverse with the MirageDrive 180, with revolutionary Kick-Up Fins that retract on impact and feature push button cranks for easy height adjustments. The sleek bow design and retractable, spring-loaded rudder offer precise handling and tracking. Two H-Track accessory rails, plenty of storage space, and a built-in transducer cavity ready for fishfinder installation make the Mirage Compass the perfect all-around kayak for any water excursion. For added stealth, upgrade to the Compass Camo package with Turbo Fins and a covert Camo color.



Available Colors:





MIRAGE COMPASS DUO

ONE KAYAK, TWO TIMES THE FUN

Enjoy on-water adventures with your family, friends and pets on the tandem Mirage Compass Duo. Pedal propulsion at its finest with one MirageDrive 180 with forward and reverse action and one MirageDrive with Glide Technology and Kick-Up Fins for a smooth and efficient ride. New for 2022 are lighter and more comfortable seats constructed with monomesh and ripstop nylon.

The Duo's sleek hull design maximizes speed and stability, while greatly reducing drag. The cockpit features comfortable, ergonomic seating, four integrated H-Tracks for accessory mounting, and abundant above and below deck storage compartments to house gear for two. The sleek waterline and Kick-Up Rudder system make for an impressively nimble tandem kayak that's easy to steer and extremely durable. The roomy Compass Duo is the ideal choice for water outings.



Available Colors:



MIRAGE COMPASS

VERSATILITY, STABILITY & POWER

1 Excellent Hull Performance
The durable hull hits the sweet spot between tracking and maneuverability. The oversized cockpit includes plenty of flat deck area for standing.

2 Forward Accessory Mount
Ready for an optional Mirage Sail Kit or Bimini Sunshade.

3 Two-Piece Paddle
Negotiate surf-strewn beaches and rocky inlets with the included Two-Piece Paddle with Fiberglass Shaft.

4 MirageDrive 180 with Kick-Up Fins
Features forward and reverse MirageDrive pedal performance. Kick-Up Fins automatically retract upon impact.

**The Camo edition comes standard with Turbo Fins
Mirage Compass Duo comes with one MirageDrive 180 and one MirageDrive GT.*

5 Drink Holder

6 Storage Abounds
Plenty of storage for your gear in the bow and stern storage areas.

7 Carrying Handles
Conveniently located midship, bow and stern.

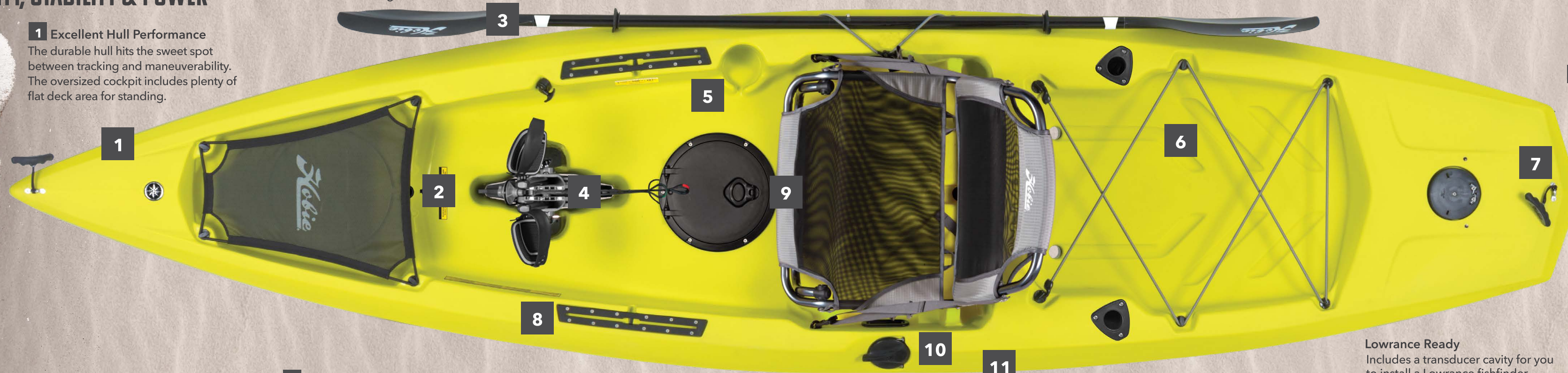

8 Accessory Ready
H-Track accessory mounts provide no-drill customization.

9 New Seat Design
Lighter, breathable and more comfortable seat design constructed with monomesh and ripstop nylon in an aluminum frame. Mounted at an ideal height for fishing, there's room for tackle storage underneath or in the seatback pouch and easily removable for use on shore.

10 Easy Steering System
When you want to paddle or head on shore, the spring-loaded rudder retracts easily into the hull and automatically kicks up if you hit something. Fingertip steering with an easy grip lever.

11 Side Carrying Handles
Improved for ease of loading and transport.

Lowrance Ready
Includes a transducer cavity for you to install a Lowrance fishfinder.

Adjustable seat is easily removable for use on shore





VANTAGE SEATING

UNPARALLELED ADJUSTABILITY FOR THE UTMOST COMFORT,
A DRIER RIDE, AND LONGER DAYS ON THE WATER.



Vantage CT

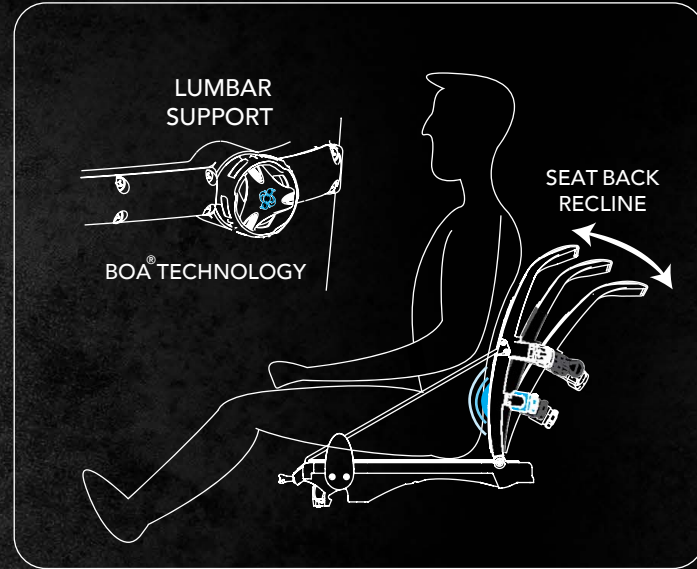

Vantage CT* and CTW Features

- Quickly and easily adjust the seat's angle of recline and height by simply pulling the lever.
- Seat bottom front and back maximum adjustability: capable of moving within a three-inch range to find your sweet spot. The Vantage CT can easily transition from a seat to a beach chair by plugging the four legs into the mounts.
- 3D Mesh allows air and water to flow naturally to let skin breathe and water drain.
- The wider Vantage CTW seat offers an extra 1-1/2 inches for ultimate comfort and is available on the Mirage Outback.

*The *Mirage Tandem Island*, *Mirage Revolution Series* and *Oasis* kayaks feature the CT seat



Vantage ST

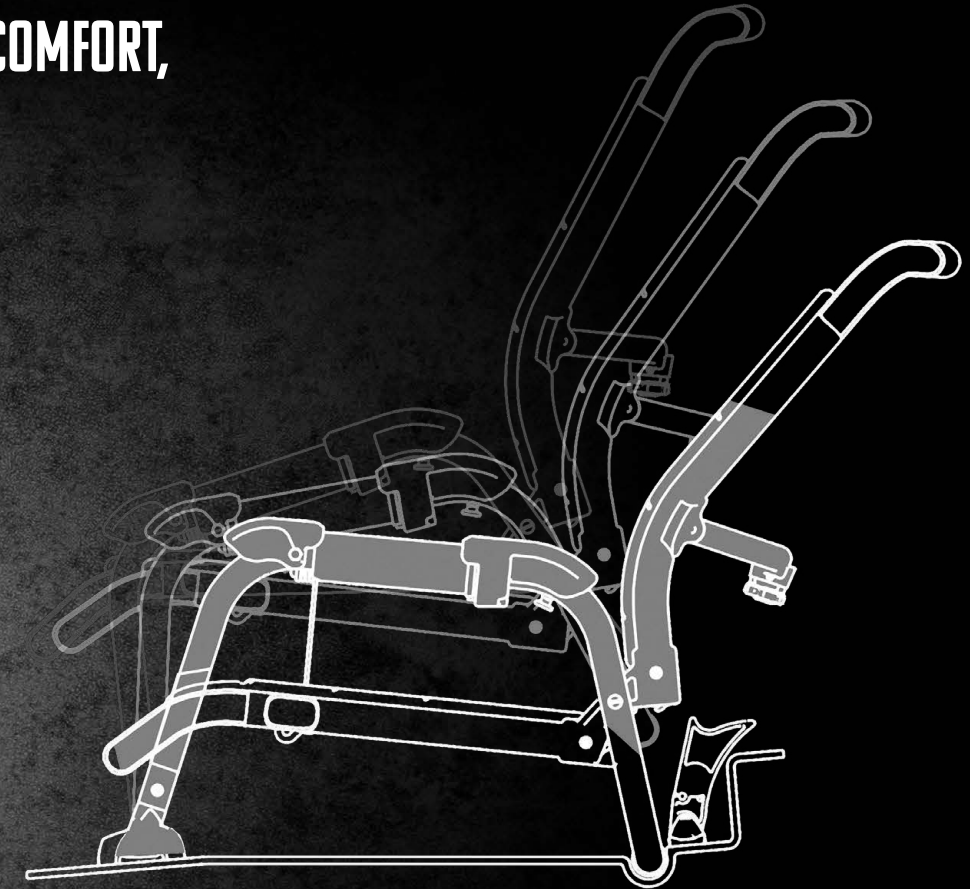

Vantage ST Features:

- The Vantage ST is equipped on the *Mirage Pro Angler Series*.
- Mesh seating allows for a dryer and more comfortable ride.
- Easily customize seat positioning with integrated barrel adjusters. Need a break? Quickly recline to relax in total comfort.
- Fold up the bottom of your seat for extra room on the standing deck.
- Raise the seat an additional five inches to enjoy optimum Vantage position.

The patented Vantage Seats maximize on-water comfort, making for a luxurious ride so you can stay focused on the environment around you. Our ergonomic Vantage Seats take adjustability and breathability to a new level, with features and materials that provide unrivaled support and comfort for a full day on the water. All Vantage Seats provide a kick stand for an even higher Vantage point and are also easy to remove and use onshore as beach chairs.



Detail of advanced Vantage mesh material



MIRAGE REVOLUTION SERIES AND OASIS

JOIN THE REVOLUTION

When speed matters most. The Mirage Revolution Series showcases the true combination of speed and power. The Revos' sleek designs makes them so fast and stable that no wave, wake, or wind can slow them down. The Revo 11 is an ideal mix of size, speed and maneuverability, easily transported to remote waters. The Revo 13 hits the sweet spot in terms of speed and tracking performance. Its 28.5" beam maximizes capacity without slowing you down, so you can hit the water with friends and always stay in the lead. Both Revos come outfitted with the industry-leading MirageDrive 180 with Kick-Up Fins, a highly adjustable Vantage CT seat, ample storage space, molded-in rod holders, and a Twist and Stow Rudder.

The Mirage Oasis is a spacious tandem kayak featuring a high-performance hull, fully loaded cockpit with highly adjustable Vantage CT seating, three Twist and Seal hatches, and easy-access storage compartments. Dual MirageDrive 180s with Kick-Up Fins power the Oasis to impressive speeds in forward and reverse. The Twist and Stow Rudder and dual steering capabilities provide enhanced tracking and maneuverability.



Available Colors:

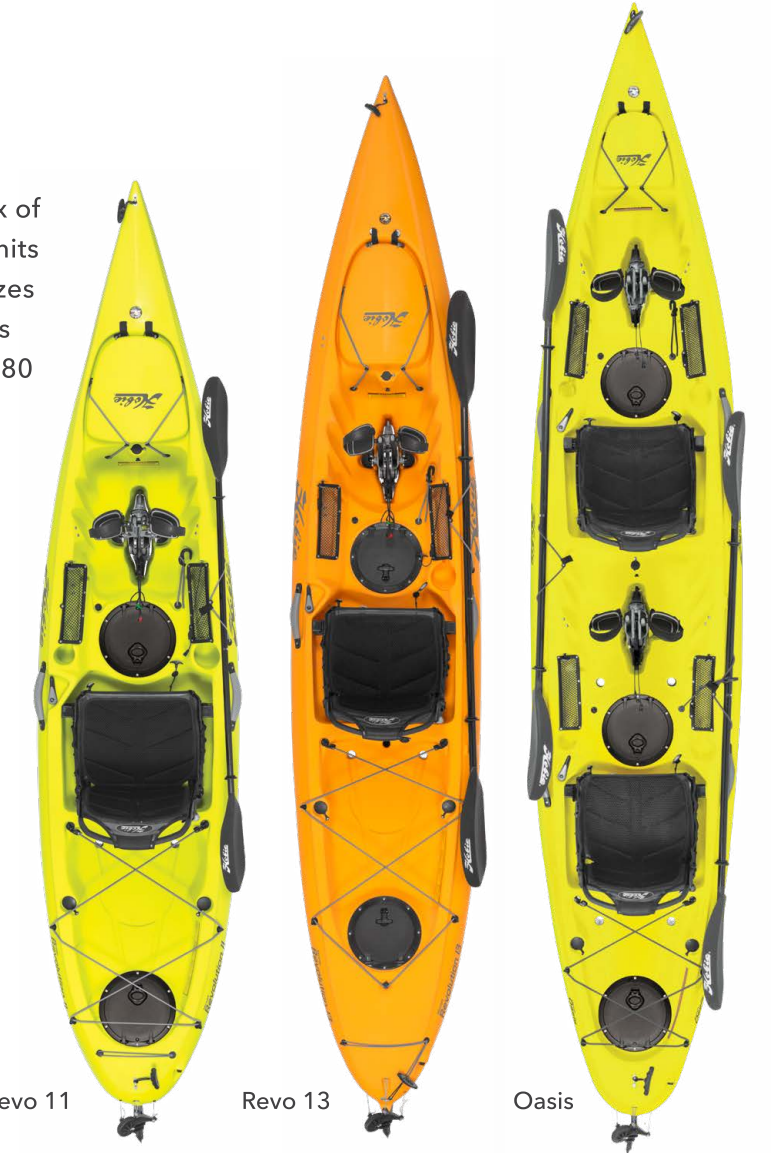
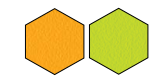

Revo 11

Revo 13

Oasis

MIRAGE REVOLUTION SERIES AND OASIS

INNOVATIVE FEATURES THAT MAKE HOBIE MIRAGEDRIVE 180 KAYAKS WORLD-RENOWNED



1 **MirageDrive 180 with Kick-Up Fins**
Gets you where you're going with minimal effort. Hobie's hands-free, forward-reverse pedal system is tough and rigorously tested. Innovative Kick-Up Fin Technology swings back when impacted so nothing can slow you down.

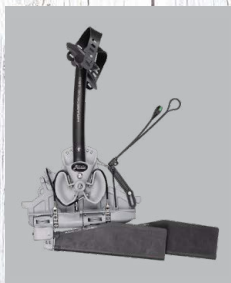

2 **Twist and Seal Hatch**
With clever corkscrew closures and hinged lids, these hatches provide in-hull storage.

3 **Vantage Seating**
Seating doesn't come any more comfortable than the hyper-adjustable Vantage CT seat.

4 **Hookless Mesh-Covered Storage Pockets & Drink Holder**
Stash fishing tools, gloves, sunscreen or other items close at hand.

5 **Two-Piece Paddle with Fiberglass Shaft**
Navigate surf-strewn beaches and rocky inlets. Bungees onto the hull when not in use.

6 **Carrying Handles**
Provided on the bow, stern and both sides, they make shore-side handling easier.



7 **Covered Bow Hatch**
Storage in spades, easy access to the hull up front. Includes dual security Bungees.

8 **Rudder Control**
The soft handle makes fingertip steering easy.

9 **Forward Accessory Mount**
The Hobie exclusive Sail Mount stands ready for an optional Mirage Sail Kit or Bimini Sunshade.

10 **Fishing Rod Holders**
Two molded-in rod holders stand ready for action.

11 **Cargo Area**
The enormous Bungee covered Cargo Area has room for camping gear, tackle, or an optional H-Crate or Livewell.

12 **Twist and Stow Rudder**
Folds onto the deck for beaching storage or shallow running.

Mirage Revolution 13 Shown



MIRAGE OUTBACK

ANGLER PREFERRED, FISH FEARED

The best-selling Mirage Outback is built for every conceivable fishing expedition. The patented, forward and reversing MirageDrive 180 comes standard with Kick-Up Fins that automatically retract for easy access to areas previously inaccessible. The extra-wide standing deck offers an improved casting platform and convenient vantage point, delivering superior vision from above while the revolutionary Guardian Transducer Shield gives you multidimensional vision below.

The Vantage CTW seat provides extra width and multiple reclining and height adjustment points for maximum comfort and visibility. Four built-in rod holders, H-Track Deluxe including H-Rail with Integrated Patented RAM® Hand-Track™, and numerous high-capacity storage compartments ensure that all of your gear is at your fingertips. This fine-tuned angling vessel is highly versatile, fast, quiet, and exceedingly nimble. Featuring our Kick-Up Rudder system with dual steering capabilities, combating drift and navigating tight water has never been easier.



Available Colors:

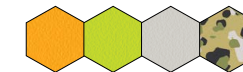

MIRAGE OUTBACK

1 Reflective Bow Graphics

2 MirageDrive 180 with Kick-Up Turbo Fins
Hobie's hands-free, forward-reverse pedal system is tough and rigorously tested. Revolutionary Kick-Up Fin Technology swings back when impacted.

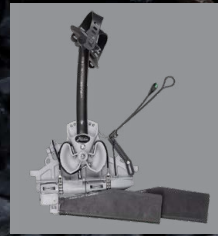

3 Notched MirageDrive Well
Recessed for better protection in shallow water.

5 Vertical Rectangular Hatch
Allows for more standing area, includes bottle opener and rubber mesh pocket.



6 Vantage CTW Seat
Wider base and seat for comfort and stability.

7 Standing Pads
Advanced EVA pads for a better grip and stability.

8 Utility Trays
Easy access gunnel storage.

9 Large Rear Handle
For ease of transport, accommodates Loader System and allows for H-Rail Accessory Mounts.

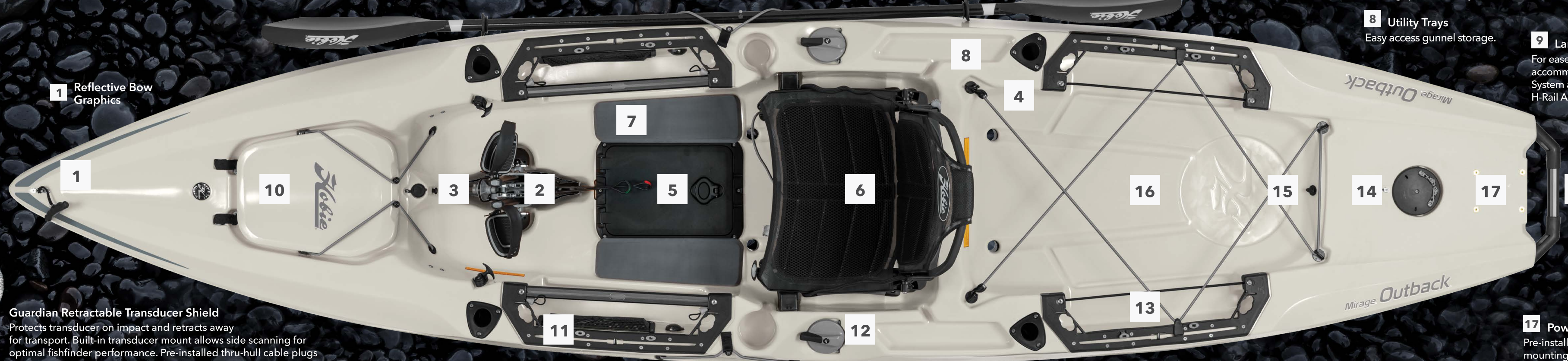

Guardian Retractable Transducer Shield
Protects transducer on impact and retracts away for transport. Built-in transducer mount allows side scanning for optimal fishfinder performance. Pre-installed thru-hull cable plugs allow quick, no-drill, no-glue fishfinder installation.



10 Front Hatch



11 H-Track Deluxe Including H-Rail With Integrated Patented RAM® Hand-Track™
Includes Side Accessory Tracks, Plier Holder, Knife Slot, Tackle Storage Retainers and an integrated leash retraction system. Easy track or H-Rail accessory mounting.

12 Dual Steering
Easily control steering from both sides of the kayak.

13 H-Track Deluxe w/ Bungee Tackle Retainer
Includes Side Accessory Tracks, Plier Holder, Knife Slot, Tackle Storage Retainers and an integrated leash retraction system.

14 Underhull Kick-Up Rudder
Automatically kicks up when it comes into contact with a solid object.

15 Cart Keeper
Bungee Locking System safely secures a kayak cart while on the water.

16 Large Rear Cargo Well

17 Power-Pole® Ready
Pre-installed inserts to make mounting a Power-Pole a cinch, no mounting plate needed.



MIRAGE PRO ANGLER 12

DESIGNED FOR LIMITLESS FISHING

Since their inception, Hobie's Pro Angler kayaks represent the ultimate fishing platform for professional anglers worldwide. For those who can tie knots in their sleep and catch bait fish with their bare hands, Pro Anglers deliver kayak fishing nirvana. The Pro Angler 12 comes fully loaded with high performance features, in a 12 foot platform. Spacious and stable, the Pro Angler 12 allows for copious gear storage with a massive front hatch and spacious cargo area, horizontal rod holders, integrated tackle storage and Hobie H-Rail for mounting any accessory imaginable. The adjustable Vantage ST seat provides an uber comfortable perch, while the massive deck with stain-resistant EVA padding is designed for stand-up fishing. Equipped with the MirageDrive 180 with the revolutionary Kick-Up Turbo Fins + adjustable push button cranks and Hobie's proprietary Guardian Retractable Transducer Shield, the PA12 is unmatched in maneuverability, stealth, and fishability.



Available Colors:



POWERED BY
MD 180

Pro Angler 12





MIRAGE PRO ANGLER 14

THE ULTIMATE FISHING MACHINE

The Pro Angler 14 continues to dominate the water and is a bucket-list item for every die-hard angler. With performance, stealth, comfort, maximum stability, precise tracking, loads of cargo space, and more features than we can list, this fishing machine stands alone. Its wide standing platform comes decked out for hauling plenty of tackle and storing rods horizontally, away from overhanging snags. The PA 14 features Hobie's award-winning forward and reversing MirageDrive 180 with Kick-Up Turbo Fins + push button cranks, adjustable and ultra-comfortable Vantage ST seat, dual steering, Guardian Retractable Transducer Shield and an extra-wide beam so you stay comfortable and confident when making tough casts from a standing position.



Available Colors:

POWERED BY
MD 180

Pro Angler 14

MIRAGEDRIVE 360

360 DEGREE, FULL-CIRCLE PEDAL PROPULSION

Over 20 years ago, Hobie revolutionized kayak fishing with the introduction of the MirageDrive pedal system. The patented MirageDrive 360 has taken kayak fishing in a direction that only Hobie can deliver - forward, backward, sideways and every degree in between. The MirageDrive 360 offers precision boat control and close-quarter maneuverability that is unrivaled by any other human-powered watercraft. Anglers can navigate tight spaces, hold position, and fish with total control. With patented Kick-Up Fin Technology, you can access shallow and obstacle-filled waters with confidence.

THE PRO ANGLER 360 SERIES OFFERS
4-WHEEL DRIVE DURABILITY,
PRECISE CONTROL AND
THE ABILITY TO TURN ON A DIME.

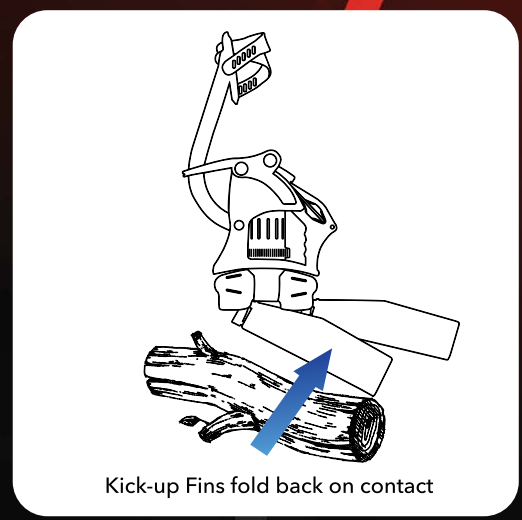

Kick-up Fins fold back on contact

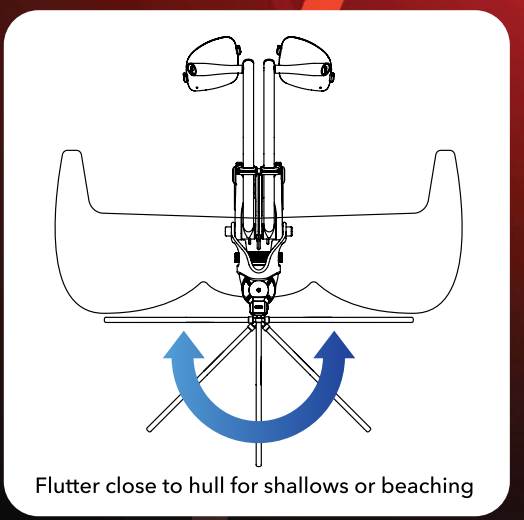

Flutter close to hull for shallows or beaching



Engineered to rotate fins a full 360 degrees



MIRAGE PRO ANGLER

360 FULL-CIRCLE 360° POWER

The Mirage Pro Angler 360 Series allows anglers to easily maneuver their fishing kayak in every direction – backwards, forward, sideways, diagonally – or even effortlessly spin on its own axis. They are as nimble as they are powerful, making it exciting to weave through obstacles and easy to stay on top of the fish. With all the fish features of the world's best-selling Hobie Mirage Pro Angler fishing kayaks, including horizontal and vertical rod storage, the adjustable, elevated Vantage ST seat, extra wide hull, Guardian Transducer Shield and stain-resistant, noise reducing EVA padding, the Mirage Pro Angler 360 Series takes kayak fishing to an entirely new level. Kick-Up Fins make shallow and structure-filled areas worry-free as they literally “kick-up” on impact. It's rock-steady platform delivers the ultimate in stability. Firecracker Red Camo with custom graphics and EVA pads is exclusively available on the Mirage Pro Angler 14 360 Mike Iaconelli Limited Edition.

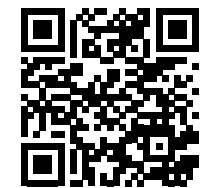

Scan code with smartphone camera for video link

Available Colors:



Pro Angler 12 360

Pro Angler 14 360

Pro Angler 14 360 Mike Iaconelli Edition

THE ULTIMATE FISHING MACHINE

1 MirageDrive 180 Powered
Keep your fishing rod in your hands - with Hobie's forward-reverse pedal system with Kick-Up Fins.
Pro Angler 360 Series offers the MirageDrive 360.

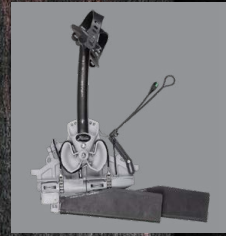

2 Vantage Seating
Take comfort to a new level with back, bottom, and BOA®-set lumbar support. Vantage Seating is easily removable for use on shore.

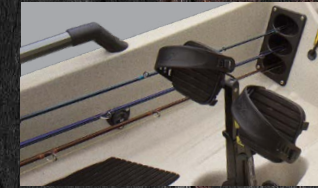

3 Horizontal Rod Storage
Keeps rods protected away from overhanging snags.

4 Rudder Control
Soft handles with dual steering (choose left or right).



H-Bar
The optional H-Bar is a sturdy leaning post and grab rail for stand-up fishing. Compatible with H-Rail accessories.

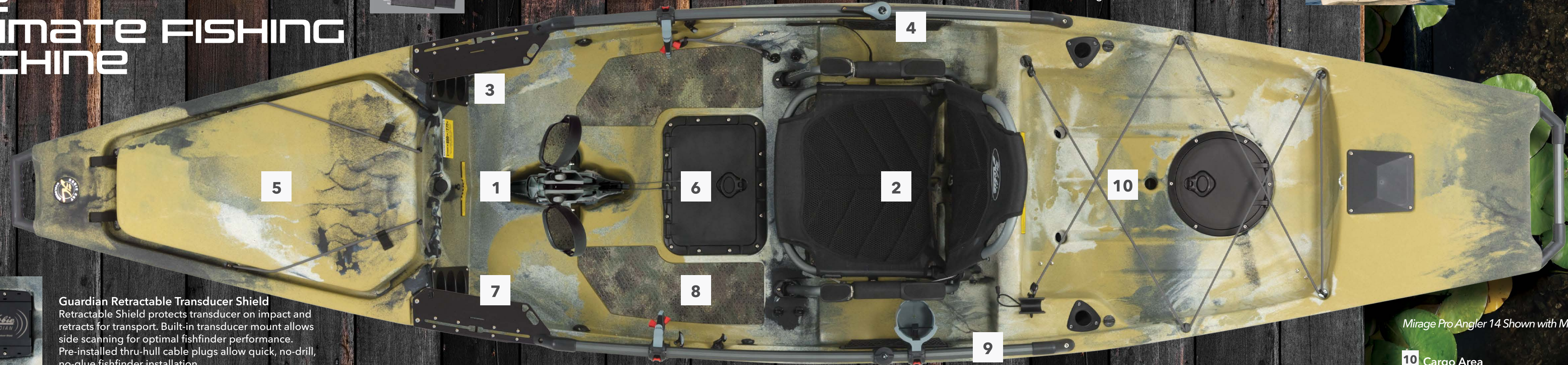

Guardian Retractable Transducer Shield
Retractable Shield protects transducer on impact and retracts for transport. Built-in transducer mount allows side scanning for optimal fishfinder performance. Pre-installed thru-hull cable plugs allow quick, no-drill, no-glue fishfinder installation.



5 Large Front Hatch with Removable Liner
Stash extra gear - there's plenty of room.

6 Pivoting Tackle Management System
Slide your tackle trays right into the PA series with ease.



7 Mounting Boards
Features an integrated track system, gear tie-down points, plier holder and knife slot.

8 Standing Platform Deck Pads
For added grip and comfort while standing.



9 H-Rail
There's no need to drill holes when rigging a Pro Angler. Twelve-sided Hobie H-Rail Bars hold a variety of accessories including Tackle Bins, Rod Racks, Cup Holders, Rod Holders and Mounting Plates.

Mirage Pro Angler 14 Shown with MD 180

10 Cargo Area
There's room for an optional H-Crate, Livewell or whatever else you need to lug. A pair of nearby vertical rod holders are ideally angled for trolling.

Skeg
Deploy the tracking skeg for improved course keeping. Retract for maneuverability.

MIRAGE TANDEM ISLAND

TIMELESS DESIGN & HOBIE INNOVATION

The Mirage Tandem Island offers a unique way to get out on the water by combining the power of the pedal with the force of the wind. Designed for superior speed and performance, the Island delivers the most exciting experience imaginable from an approachable, easy-to-learn platform. Built for sailors of any size and experience level, the Tandem Island offers an unmatched experience for those seeking fun family outings as well as adventurers looking to push the limits of man and craft. Simple to launch and beach, it's easy to get started but hard to want to stop.

1 Roller Furling Boomless Mainsails
Providing a powerful yet user-friendly ride, the sail wraps easily around the carbon composite mast, making it simple to unfurl, trim and furl in all conditions.

2 Island Rudder
The oversized rudder makes steering effortless and precise, enabling maximum maneuverability.

3 Kick-Up Centerboard
The Kick-Up Centerboard is fully retractable and improves tracking performance while under sail.

4 Dual MirageDrive 180s
+ Turbo Kick-Up Fins
Outfitted with two MirageDrive 180s, experience unrivaled power in both forward and reverse.

5 Aka Crossbars
The crossbars pivot back against the hull for easy transportation, docking and storage, or to help land a prized catch.

6 Ama Outriggers
The durable Ama Outriggers provide the Islands with confidence-inspiring stability.



Available Colors:

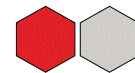

POWERED BY
MD 180



ACCESSORIES FOR MORE KAYAKING PARTS & ACCESSORIES VISIT HOBIE.COM



Elite FS™ 7

The Elite Fishing System (FS) combines the power of Lowrance's proven and newest fishfinding tools with a more affordable display that's easier to use. ActiveTarget™ Live Sonar compatible. Active Imaging 3-in-1 transducer included. FishReveal™, preloaded C-Map® Contour+ inland and coastal charts with 1-foot contours on 15,000+ US lakes and 9,400+ Canadian lakes. C-Map Genesis Live onscreen mapping. High-resolution multi-touch touchscreen. Integrated wireless, NMEA 2000® and Ethernet connectivity. Full touchscreen control of Power Pole® anchor. Compatible mount: 72023055 RAM MOUNT 1.5" paired with 1.5" RAM ball of choice.

72020223 ELITE FS 7 AI 3-IN-1 US/CAN

H-Crate

Hobie's H-Crates keep your tackle and other gear organized in one easy-to-reach space. Both models of the H-Crate are easily removable, incorporate four vertical rod holders with Bungee retainers, and integrate H-Rail carrying handles that double as a mounting platform. For the ultimate experience add a soft cover, additional vertical rod holders or any H-Rail accessory in our line to your H-Crate or H-Crate Jr.

72020088 H-CRATE
72020097 H-CRATE SOFT COVER
72020298 H-CRATE JR.
72020297 H-CRATE JR. SOFT COVER
72020015 ADDITIONAL ROD HOLDER

Inflatable PFD

Light weight and comfortable. Ready when you need it, manual CO₂ inflation or by mouth inflator allows for swimming, wading and intentional immersion. Available in Blue, Red, Green/Hobie fish pattern, Tan/Hobie fish pattern.

S6782BL BLUE
S6782GR GREEN
S6782RD RED
S6782TN TAN
S6779R PFD INFLATABLE REARM KIT

Note: Air Shipping Restrictions CO₂ / Dangerous Goods

Mirage Sail Kit

Comes with two-piece mast a 20.25 sq. ft. sail, lines, fittings and a storage bag.

84512002 RED/SILVER
84514002 ORANGE/PAPAYA
84513002 SILVER/CHARTREUSE
84515002 CHARTREUSE/AQUA
84516002 PAPAYA/WHITE



Hobie Bimini

Relax all day under the cool shade of our all new kayak Bimini. UPF 50+ fabric and sophisticated articulation feature provide sun and rain protection no matter the time of day. Made with water-resistant and lightweight ripstop nylon the shade is rugged and durable.

72020520 HOBIE BIMINI POSEIDON BLUE
72020521 HOBIE BIMINI MARINE GRAY
72020522 HOBIE BIMINI SUN YELLOW



Livewell V2

The newly redesigned Hobie Livewell sports a fresh color scheme, modern lines and more built-in features than ever before. This Livewell is plug-and-play with most Hobie kayaks and includes: (1) 6V sealed gel cell battery + charger for powering the pump, an adjustable downspout for filling the tank half way, a corrosion resistant power switch, 3 integrated rod holders, a threaded drain plug, easily removable tank partitions for keeping bait healthy, an 8" Twist and Seal Hatch for access and bait concealment, heavy-duty straps for attaching it to the kayak and a carrying handle for easy transport.

72020077 LIVEWELL V2
72020015 ADDITIONAL ROD HOLDER



Vantage Seat Accessory Bag

The Vantage Seat Accessory Bag is the perfect addition to your MirageDrive kayak. Ideal for storing extra tackle, keys and wallet, lunch, a foul weather jacket, birding glasses, safety gear and more.

Dimensions: Approx. 8" Tall x 8" Wide x 3" Deep.

72020117 VANTAGE SEAT ACCESSORY BAG



Fold and Stow Cart

Fold and Stow cart weighs in at 5 pounds, functions well on solid to semi-soft surfaces, and conveniently breaks down to stow inside the bow hatch of any rotomolded Hobie kayak equipped with the large front cargo hatch.

80047001 FOLD AND STOW CART
FIXED FRAME CARTS ALSO AVAILABLE:
80045001 STANDARD CART
80046001 HEAVY DUTY CART
80044101 TRAX 2 CART
80043001 TRAX 2-30

ACCESSORIES



Fish Bag/Soft Cooler

Keep your food or catch cold all day, even in very hot conditions. High quality construction includes half-inch closed cell foam that insulates, vinyl coated polyester that's durable and YKK zippers that are strong. Has handles for carrying and d-rings on the sides for attaching to the kayak. Design features for storing additional gear on all bag sizes.

72020118 COOLER / FISH BAG - XL
72020111 COOLER / FISH BAG - LARGE
72020113 COOLER / FISH BAG - MEDIUM
72020114 COOLER / FISH BAG - SMALL



Adjustable H-Bar

Standing support for kayaks! The adjustable H-Bar integrates with all H-Rail accessories for easy customization. It folds up when you need it and away when you don't. The aluminum extrusion is strong and lightweight for leaning against or holding on to while entering/exiting the boat or pulling yourself up from a seated to a standing position. Fully adjustable to fit a wide variety of kayaks.

84500115 PA-17 H-RAIL ADAPTER KIT
84500116 H-BAR FOR PRO ANGLER
84500117 H-BAR FOR COMPASS
84500119 H-BAR PRE-2019 OUTBACK/UNIVERSAL
84500120 H-BAR FOR OUTBACK 2019+
84500121 HOBIE H-BAR PASSPORT 12
84626106 LYNX KIT



Kayak Kusion

This seat pad is comprised of a breathable, patented foam that won't absorb water when wet. Made in the USA with military grade components, this lightweight, advanced foam technology won't break down over time. Nylon webbing straps with non-slip cam buckles make installation and removal easy. The breathable mesh cover zips off for easy washing.

72026220 HOBIE KUSHION FIRM-BLACK
72026221 HOBIE KUSHION FIRM-OG GREEN



H-Rail Mini Tackle Bin

The H-Rail Mini Bin packs serious utility! It's slim and rugged design features a built-in 42" retractable gear tether, a tool holder for pliers or fish grips, four clip points for leashing down gear and raised drain channels in the floor so your gear won't ever sit in water. Four mounting locations for its integrated H-Rail clamp allows for a variety of orientations, giving you the flexibility to mount the bin just about anywhere you've got an open section of H-Rail. Perfect for holding the tools you need close to hand.

84623004 MINI TACKLE BIN / H-RAIL



EVA Deck Pad Kits

Hobie's EVA deck pad kits are custom fit to every curve of your kayak and deliver supreme comfort, traction and sound dampening qualities.

72020250 PA14 GREEN/ESPRESSO
72020251 PA14 TITANIUM/BLUE
72020252 PA14 GREY/CHARCOAL
72020253 PA12 GREEN/ESPRESSO
72020254 PA12 TITANIUM/BLUE
72020255 PA12 GREY/CHARCOAL
72020261 2019 OUTBACK TITANIUM/AEGAN BLUE
72020264 2019 OUTBACK 2019 GREEN/ESPRESSO
72020267 2019 OUTBACK GREY/CHARCOAL
72020240 PA 12 360 GREY/BLACK
72020241 PA 12 360 BLACK/GREY
72020242 PA 14 360 GREY/BLACK
72020243 PA 14 360 BLACK/GREY
72020305 LYNX GREY/CHARCOAL



Hobie Thin-Back Life Vest

Features a thin foam back design... perfect for use with Hobie Vantage seats. This thinner back profile provides more mobility and comfort, while reducing interference with taller seat backs.

S6104XX (XX = SIZE) MENS SLATE
S6107XX (XX = SIZE) MENS FISH SLATE GREEN
S6105XX (XX = SIZE) WOMEN'S SUN
S6106XX (XX = SIZE) WOMEN'S SLATE



Power-Pole® Micro Anchor and Spike

Fast and secure anchoring for Hobie Pro Angler or Outback. Includes Micro Driver Unit and and new 8' UL Spike.. This all-electric unit is extremely quiet and easy to use. It works with a 3/4" spike to stop and anchor your kayak at the push of a button. It functions as a conventional stakeout pole or shallow water anchor without having to manually deploy it. With Power-Pole's signature strong hold, the Micro gives you a smooth stop in seconds.

72020083 POWER-POLE MICRO AND SPIKE
(Pro Angler series and pre-2019 Outback, Compass and Compass Duo requires mounting kits to properly distribute loads. 2019+ Outback and Lynx require hardware kit. Passport 12 uses bolts provided with your Power-Pole Micro unit. Not approved for use on other Hobie models at this time)



Tie-Down Straps

Rack tie-down straps, made of durable black polypropylene webbing. Diagonal cut and ironed ends make threading ends into buckles easier.

72042001 TIE DOWNS 12' (PAIR)
72043001 TIE DOWNS 15' (PAIR)

THE MIRAGE FLEET



MIRAGE KAYAKS

PASSPORT 10.5 **PASSPORT 12** **COMPASS** **COMPASS DUO** **OUTBACK** **REVOLUTION 11** **REVOLUTION 13** **OASIS** **LYNX**

MIRAGE iTREK INFLATABLES

iTREK 9 **iTREK 11** **iTREK 14 DUO** **FIESTA**

MIRAGE PRO ANGLERS

PRO ANGLER 12 **PRO ANGLER 14** **PRO ANGLER 12 360** **PRO ANGLER 14 360** **PRO ANGLER 14 360 MIKE IACONELLI EDITION**

MIRAGE ISLAND

TANDEM ISLAND

CREW	Single	Single	Single	Tandem	Single	Single	Single	Tandem	Single	Single	Single	Tandem	Seats Four	Single	Single	Single	Single	Single	Single	Tandem
LENGTH	10.5' / 3.2 m	12' / 3.66 m	12' / 3.66 m	13' 5" / 4.11 m	12' 9" / 3.89 m	11' 6" / 3.51 m	13' 5" / 4.09 m	14' 6" / 4.42 m	11" / 3.35 m	9'5" / 2.87 m	10'8" / 3.25 m	13'8" / 4.17 m	15' / 4.57m	12' / 3.66 m	13' 8" / 4.17 m	12' / 3.66 m	13' 8" / 4.17 m	13' 8" / 4.17 m	13' 8" / 4.17 m	18' 6" / 5.64 m
WIDTH	34" / 0.86 m	34" / 0.86 m	34" / 0.86 m	35" / 0.89 m	34" / 0.86 m	29" / 0.74 m	28.5" / 0.72 m	33" / 0.84 m	36" / 91.44 cm	40" / 1.02 m	40" / 1.02 m	44" / 1.12 m	80" / 2.03 m	36" / 0.91 m	38" / 0.97 m	36" / 0.91 m	38" / 0.97 m	38" / 0.97 m	38" / 0.97 m	18' 6" / 5.64 m w/ Amas Out: 10' / 3.05 m w/ Amas In: 4' / 1.22 m
CAPACITY	325 lbs. / 147.42 kg #	400 lbs. / 181 kg #	400 lbs. / 181 kg #	475 lbs. / 215.5 kg #	425 lbs. / 192.78 kg #	275 lbs. / 125 kg #	350 lbs. / 159 kg #	550 lbs. / 249 kg *#	350 lbs / 158.76 kg	350 lbs. / 158.8 kg	400 lbs. / 181.4 kg #	600 lbs. / 272 kg #	1000 lbs. / 453.6 kg #	500 lbs. / 227 kg #	600 lbs. / 272 kg #	500 lbs. / 227 kg #	600 lbs. / 272 kg #	600 lbs. / 272 kg #	600 lbs. / 272 kg #	600 lbs. / 272 kg #
FITTED HULL WEIGHT	65 lbs. / 29.48 kg	73 lbs. / 33.1 kg	68 lbs. / 31 kg	92 lbs. / 41.7 kg	85 lbs. / 38.56 kg	64 lbs. / 29 kg	70.5 lbs. / 32 kg	93 lbs. / 42 kg	47 lbs / 21.32 kg	20 lbs. / 9 kg	28 lbs. / 12.7 kg	45 lbs. / 20.4 kg	78 lbs. / 35.4 kg	105 lbs. / 48 kg	120.5 lbs. / 55 kg	109.5 lbs. / 49.7 kg	124.5 lbs. / 56.5 kg	124.5 lbs. / 56.5 kg	124.5 lbs. / 56.5 kg	130 lbs. / 59 kg
FULLY RIGGED WEIGHT	75 lbs. / 34.02 kg	83 lbs. / 37.6 kg	87 lbs. / 39 kg	127 lbs. / 57.6 kg	103 lbs. / 46.72 kg	81 lbs. / 37 kg	88 lbs. / 40 kg	130 lbs. / 58 kg	63 lbs / 28.58 kg	37 lbs / 16.8 kg	44 lbs. / 19.96 kg	73 lbs. / 33.1 kg	105 lbs. / 47.63 kg	128.5 lbs. / 58.29 kg	144.5 lbs. / 65.54 kg	132.5 lbs. / 60.1 kg	148.5 lbs. / 67.4 kg	148.5 lbs. / 67.4 kg	148.5 lbs. / 67.4 kg	240 lbs. / 109 kg



COLORS

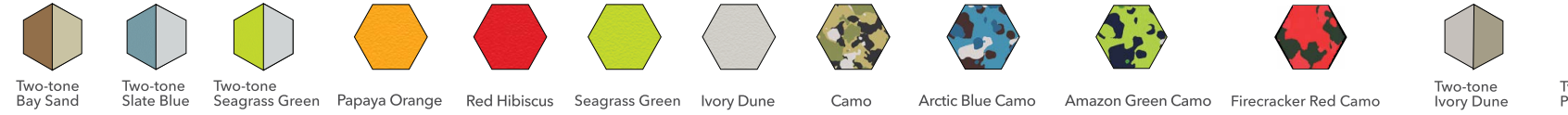

NOTES

Fitted Hull Weight: Includes all permanently-attached standard features (e.g., hatches, handles, rudder, hardware).

Fully Rigged Weight: Includes the Fitted Hull Weight, plus all other standard features that are removable, e.g. MirageDrive, seat, paddles, gear bucket, cassette plug, Pro Anglers (removable liner), Islands (sail, amas, akas, daggerboard), Inflatables (travel bag, pump, repair kit).

Meets NMMA (National Marine Manufacturers Association) certification for flotation.

* See website for info on load distribution

All colors, graphics and specifications of all models are subject to change without notice.

Published boat dimensions are estimated and may deviate slightly due to unavoidable manufacturing variables.

Hobie



HOBIE

Global Headquarters
Oceanside, CA, U.S.A.

HOBIE AUSTRALASIA

Huskisson, NSW, Australia

HOBIE EUROPE

Toulon, France

HOBIE KAYAK EUROPE

Stellendam, The Netherlands

HOBIE BRASIL

Porto Belo, Santa Catarina, Brasil

Mirage Outback Featured

87369364

www.hobie.com